

48-V to 3.3-V Forward Converter with Active Clamp Reset Using the UCC2891 Active Clamp Current Mode PWM Controller

User's Guide

48-V to 3.3-V Forward Converter with Active Clamp Reset Using the UCC2891 Active Clamp Current Mode PWM Controller

User's Guide

Literature Number: SLUU178A
November 2003—Revised December 2006

Using the UCC2891 Active Clamp Current Mode PWM Controller

1 Introduction

The UCC2891EVM evaluation module (EVM) is a forward converter providing a 3.3-V regulated output at 30 A of load current, operating from a 48-V input. The EVM operates over the full 36 V to 72 V telecom input range, and is able to fully regulate down to zero load current. The module uses the UCC2891 current mode active clamp PWM controller for effectively demonstrating the active clamp transformer reset technique.

Benefits of the active clamp include a control driven transformer reset scheme allowing zero voltage switching (ZVS) to increase overall efficiency, lower drain-to-source voltage stress, extended duty cycle beyond 50% and reduced electromagnetic radiated emissions. Combined with synchronous rectification, this EVM is configured to operate at 300 kHz and exhibits a peak efficiency of just over 92%, with a full load efficiency of 89%. The EVM displays many features that might be typical of a more complex design, yet its compact board layout and low component count make it elegantly simple.

2 Description

The UCC2891 controller family provides advanced active clamp control features such as programmable maximum duty cycle clamp, programmable dead time between the two primary switches and the ability to drive either a P-channel, or N-channel MOSFET in either a high-side or low-side active clamp configuration. The UCC2891 also allows the ability to start-up directly from the 48-V telecom bus voltage, eliminating the need for external start-up circuitry. It includes programmable soft start, internal slope compensation for peak current mode control, internal low-line voltage sensing, internal synchronizable clock input, cycle-by-cycle current limiting, and a robust 2-A sink/source TrueDrive™ internal gate drive circuit. The result is a highly efficient design loaded with features, requiring very few external components.

The TrueDrive™ hybrid output architecture used in the UCC2891 uses TI's unique TrueDrive™ Bipolar/CMOS output. To the user, this simply means ultra-fast rise and fall times by providing the highest possible drive current where it is needed most, at the MOSFET Miller plateau region.

The UCC2891/2/3/4 is available in either a 16-pin SOIC or 16-pin TSSOP package for applications where absolute minimal board space is required.

The UCC2891EVM highlights the many benefits of using the UCC2891 active clamp current mode PWM controller. This user's guide provides the schematic, component list, assembly drawing, artwork and test set up necessary to evaluate the UCC2891 in a typical telecom application. More detailed design information can be found listed in the References section.

2.1 Applications

The UCC2891 is suited for use in isolated telecom 48-V input systems requiring high-efficiency and high-power density for very low-output voltage, high-current converter applications, including:

- Server Systems
- Datacom
- Telecom
- DSP's, ASIC's, FPGA's

2.2 Features

The UCC2891EVM features include:

- ZVS transformer reset using active clamp technique in forward converter
- All surface mount components, double sided half brick (2.2 × 2.28 × 0.5) inches
- Complementary auxilliary drive for active clamp with programmable dead time for ZVS
- Current mode control with synchronization function
- Internal PWM slope compensation
- Start-up directly from telecom input voltage
- Synchronous rectifier output stage allows high-efficiency operation
- Programmable soft-start
- Up to 30-A dc output current
- Regulation to zero load current
- Non-latching, output overcurrent and short circuit protection
- Non-latching, Input undervoltage protection
- 1500-V isolation primary to secondary

3 UCC2891EVM Electrical Performance Specifications

The UCC2891EVM electrical performance specifications are listed in [Table 1](#).

Table 1. UCC2891EVM Performance Summary

PARAMETER	TEST CONDITIONS	MIN	TYP	MAX	UNITS
Input Characteristics					
Input voltage range		36	48	72	V
No load input current	$V_{IN} = 36\text{ V}, I_{OUT} = 0\text{ A}$		75	100	mA
Maximum input current	$V_{IN} = 36\text{ V}, I_{OUT} = 30\text{ A}$		3.00	3.25	A
Input voltage ripple	$V_{IN} = 72\text{ V}, I_{OUT} = 30\text{ A}$		1.50	1.75	V_{P-P}
Input voltage ripple					
Output voltage	$36\text{ V} \leq V_{IN} \leq 72\text{ V}, 0\text{ A} \leq I_{OUT} \leq 30\text{ A}$	3.25	3.30	3.35	V
Output voltage regulation	Line regulation ($36\text{ V} \leq V_{IN} \leq 72\text{ V}, I_{OUT} = 0\text{ A}$)		0.003%		
	Load regulation ($0\text{ A} \leq I_{OUT} \leq 30\text{ A}, V_{IN} = 48\text{ V}$)		0.060%		
Output voltage ripple	$V_{IN} = 48\text{ V}, I_{OUT} = 30\text{ A}$		30	35	mV _{P-P}
Output load current	$V_{IN} = 48\text{ V}, I_{OUT} = 30\text{ A}$	0		30	A
Output current limit	$36\text{ V} \leq V_{IN} \leq 72\text{ V}$			32	
Output current limit					
Switching frequency		275		325	kHz
Control loop bandwidth	$36\text{ V} \leq V_{IN} \leq 72\text{ V}, I_{OUT} = 10\text{ A}$	5		8	
Control loop bandwidth	$36\text{ V} \leq V_{IN} \leq 72\text{ V}, 2\text{ A} \leq I_{OUT} \leq 30\text{ A}$	30		50	°C
Peak efficiency			92%		
Full load efficiency	$V_{IN} = 48\text{ V}, I_{OUT} = 30\text{ A}$		89%		

4 Schematic

A schematic of the UCC2891EVM is shown in [Figure 1](#). Terminal block J1 is the 48-V input voltage source connector and J8 is the output and return for the 3.3-V output voltage.

On the primary side, U1 is the UCC2891 shown with the necessary discrete circuitry for configuring the controller to operate at 300 kHz with the maximum duty clamp set for 0.65. The EVM is programmed to start at $V_{IN}=36\text{ V}$, as determined by R11 and R12. To minimize power dissipation in the current sense, a current sense transformer, T1 is used, as opposed to simply using a sense resistor between the source of Q2 and power ground. Q2 is the primary switching MOSFET and is selected based upon V_{DS} and low $R_{DS(on)}$. Q1 is the AUX (active reset) MOSFET and is selected based upon preferred package only, with only minor consideration given for $R_{DS(on)}$ and Q_g . Since the active clamp used in this design is low-side referenced, Q1 must be a P-channel type MOSFET. The reason for this is further explained in application note SLUA299[2]. C9 is the clamp capacitor used to maintain a constant dc voltage. The input voltage is subtracted from the clamp voltage to allow transformer reset during the active clamp period.

Schematic

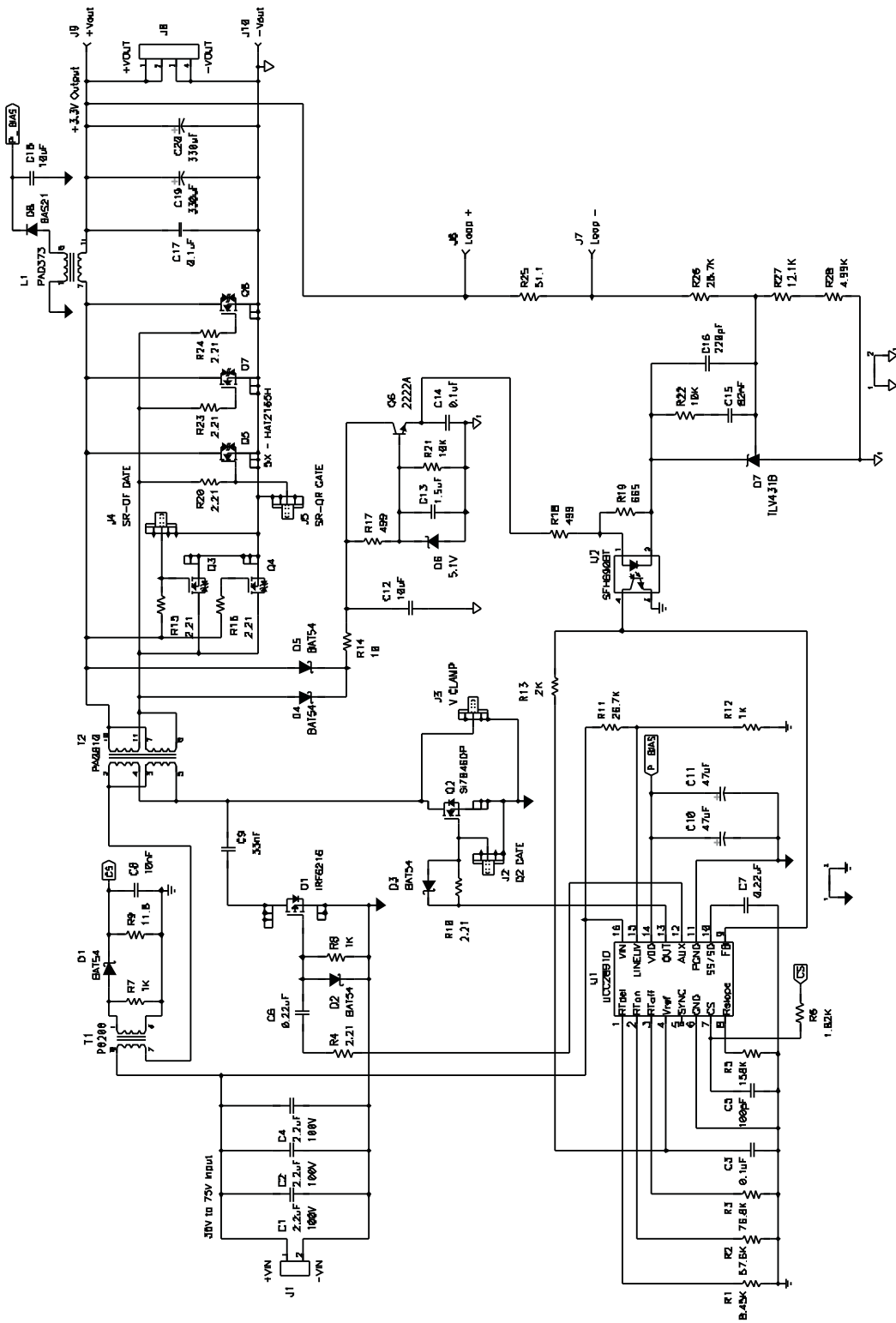

Figure 1. UCC2891EVM Schematic

High efficiency is achieved using self-driven synchronous rectification on the secondary side. Q3 and Q4 are placed in parallel and make up the forward synchronous rectifier (SR), while the reverse SR is made up of the parallel combination of Q5, Q7 and Q8. If the duty cycle were limited to 50% then the reverse SR could be reduced to only two parallel MOSFETs, but since these devices are operating near 60% duty cycle during the freewheel mode, they carry a higher average current than seen by Q3 and Q4. The output inductor L1 has a coupled secondary, referenced to the primary side, used to provide bootstrapping voltage to U1. A stable bias for the optocoupler, U2 is provided by the series pass regulator made up of D6, Q6 and some associated filtering.

Scope jacks J2 and J3 allow the user to measure the gate-to-source and drain-to-source signals for Q2, the primary MOSFET. J4 and J5 allow convenient access to the gate drive signals of each SR on the secondary side. J6 and J7 are available allowing the option of using a network analyzer to non-invasively measure the control to output loop gain and phase.

5 EVM Test Setup

Figure 2 shows the basic test set up recommended to evaluate the UCC2891EVM.

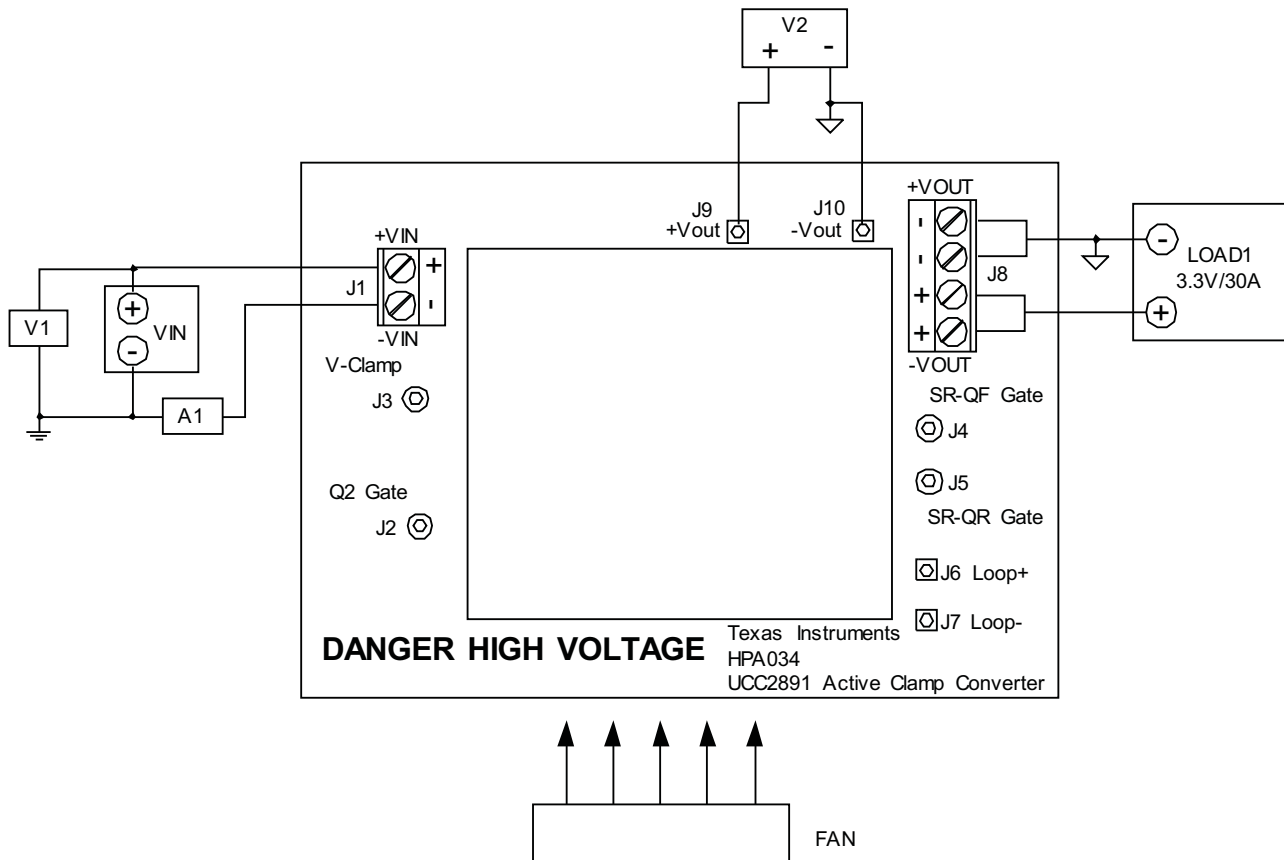

Figure 2. Recommended EVM Test Configuration

5.1 Output Load (LOAD1)

For the output load to VOUT, a programmable electronic load set to constant current mode and capable of sinking between $0A_{DC}$ and $30A_{DC}$, is used. Using a dc voltmeter, V2, it is also advised to make all output voltage measurements directly at J9 and J10 pins. Unless the load has remote sense capability, measuring VOUT at LOAD1 results in some voltage measurement error, especially at higher load current, due to finite voltage drops across the wires between J8 and the electronic load.

5.2 DC Input Source (VIN)

The input voltage is a variable DC source capable of supplying between $0V_{DC}$ and $72V_{DC}$ at no less than $3.5A_{DC}$, and connected to J1 and A1 as shown in [Figure 2](#). For fault protection to the EVM, good common practice is to limit the source current to no more than $4A_{DC}$ for a 36 V input. A dc ammeter, A1 should also be inserted between VIN and J1 as shown in [Figure 2](#).

5.3 Network Analyzer

A network analyzer can be connected directly to J6 and J7. The UCC2891EVM provides a $51.1\text{-}\Omega$ resistor (R25) between the output and the voltage feedback to allow easy non-invasive measurement of the control to output loop response.

5.4 Recommended Wire Gauge

The connection between the source voltage, VIN and J1 of the EVM can carry as much as $3.25A_{DC}$. The minimum recommended wire size is AWG #20 with the total length of wire less than 8 feet (4 feet input, 4 feet return). The connection between J8 of the EVM and LOAD1 can carry as much as $30A_{DC}$. The minimum recommended wire size is AWG #16, with the total length of wire less than 8 feet (4 feet output, 4 feet return).

5.5 Fan

Most power converters include components that can be hot to the touch when approaching temperatures of 60°C . Because this EVM is not enclosed to allow probing of circuit nodes, a small fan capable of 200-400 LFM is recommended to reduce component temperatures when operating at or above 50% maximum rated load current.

6 Power Up/Down Test Procedures

The following test procedure is recommended primarily for power up and shutting down the EVM. Whenever the EVM is running above an output load of 15 A_{DC}, the fan should be turned on. Also, never walk away from a powered EVM for extended periods of time.

1. Working at an ESD workstation, make sure that any wrist straps, bootstraps or mats are connected referencing the user to earth ground before power is applied to the EVM. Electrostatic smock and safety glasses should also be worn.
2. Prior to connecting the DC input source, VIN, it is advisable to limit the source current from VIN to 3.5-A maximum. Make sure VIN is initially set to 0 V and connected to J1 as shown in [Figure 2](#).
3. Connect the ammeter A1 (0A to 10A range) between VIN and J1 as shown in [Figure 2](#).
4. Connect voltmeter (can optionally use voltmeter from VIN source if available), V1 across VIN as shown in [Figure 2](#).
5. Connect LOAD1 to J8 as shown in [Figure 2](#). Set LOAD1 to constant current mode to sink 0 A_{DC} before VIN is applied.
6. Connect voltmeter, V2 across J9 and J10 as shown in [Figure 2](#).
7. Increase VIN from 0 V to 36 V_{DC}.
8. Observe that VOUT is regulating when VIN is at 36 V.
9. Increase VIN to 48 V.
10. Increase LOAD1 from 0 A to 15 A_{DC}.
11. Turn on fan making sure to blow air directly on the EVM.
12. Increase LOAD1 from 15 A_{DC} to 30 A_{DC}.
13. Decrease LOAD1 to 0 A.
14. Decrease VIN from 48 V_{DC} to 0 V.
15. Shut down VIN.

7 Power Up/Down Test Procedures

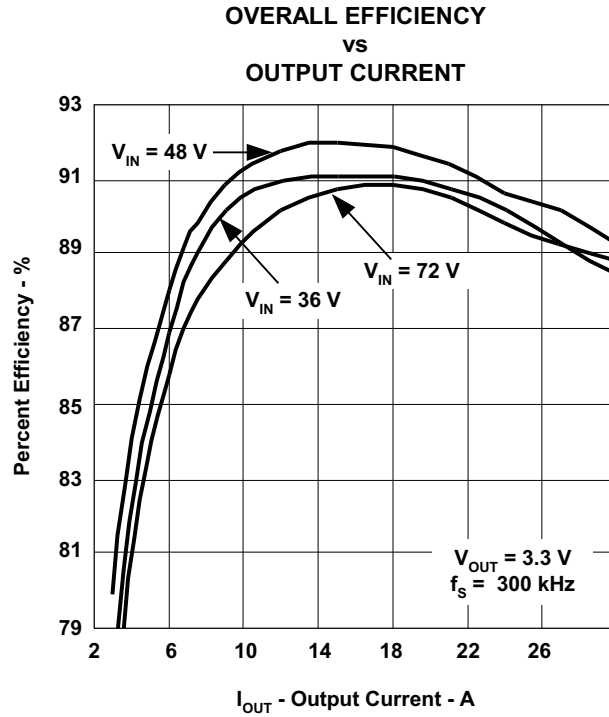

Figure 3.

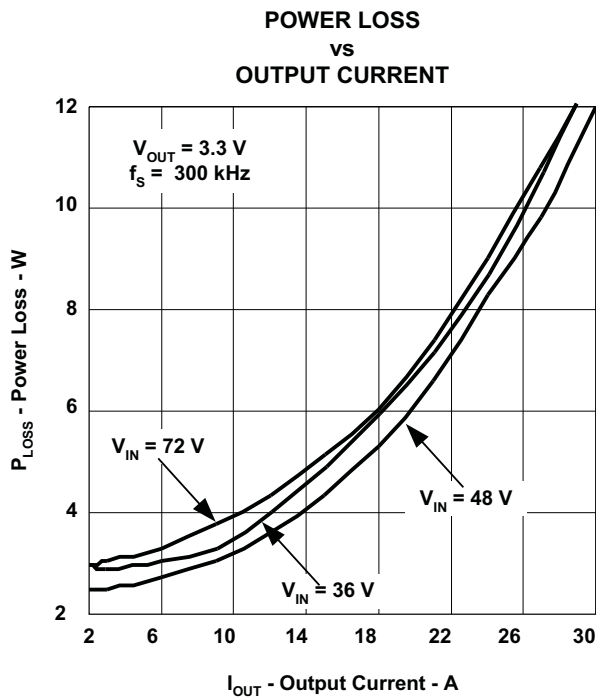

Figure 4.

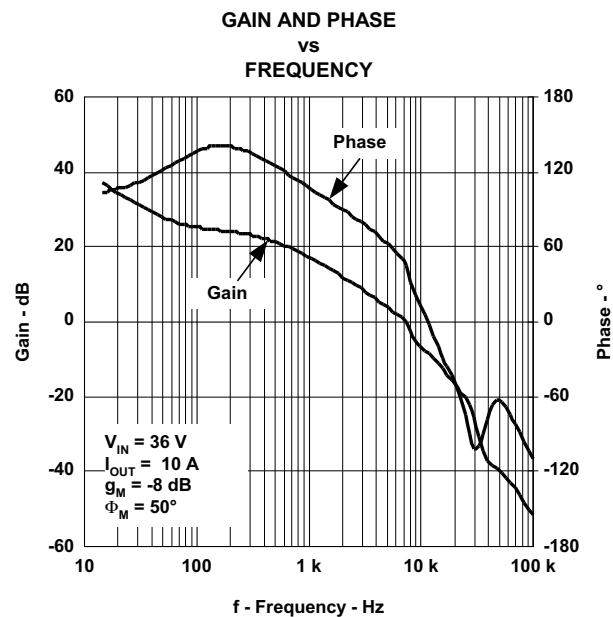

Figure 5.

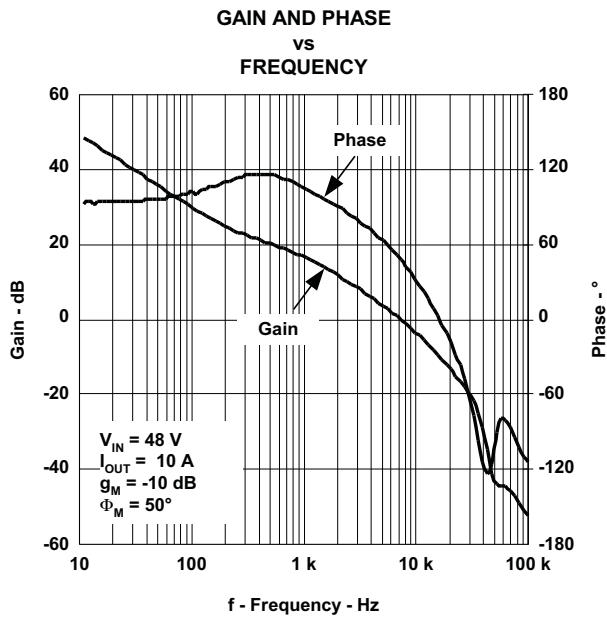

Figure 6.

Input Ripple Voltage

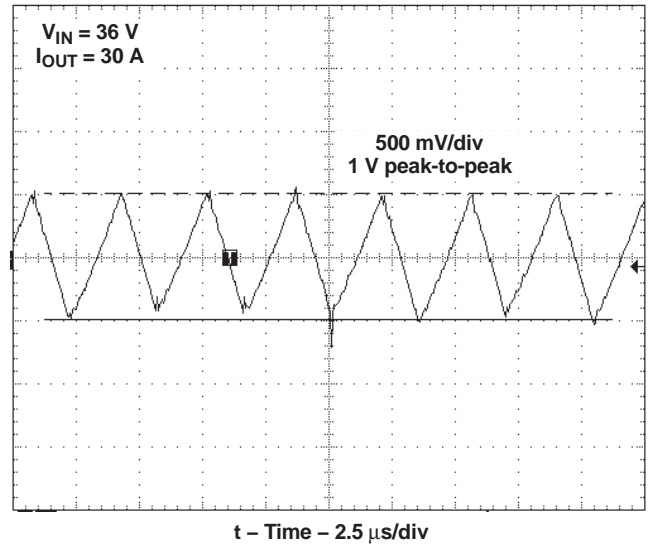

Figure 8.

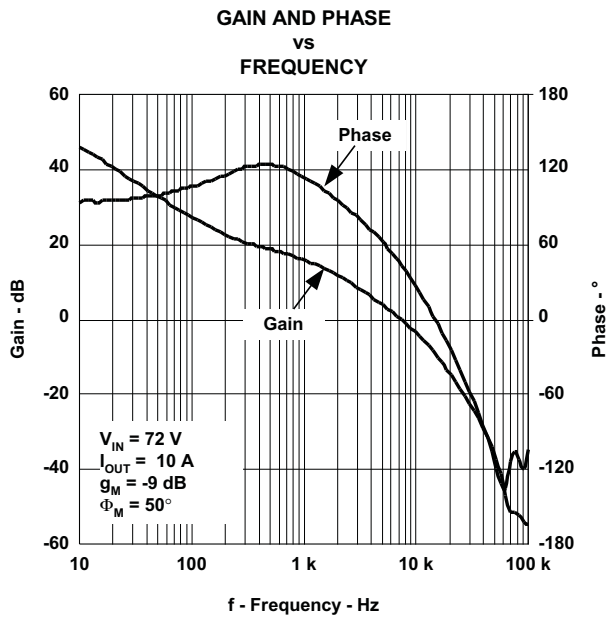

Figure 7.

Output Ripple Voltage

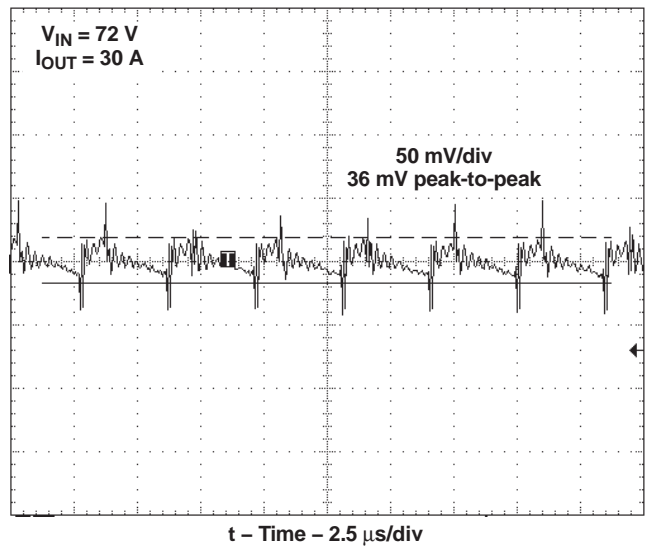
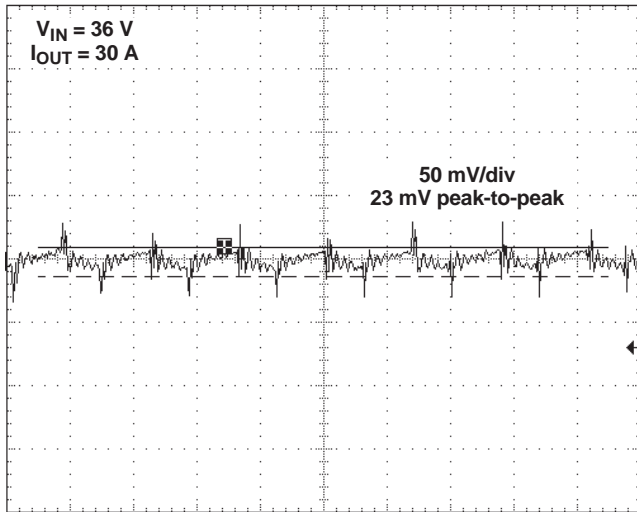

Figure 9.

Output Ripple Voltage



t – Time – 2.5 $\mu\text{s}/\text{div}$

Figure 10.

SR Gate Drive

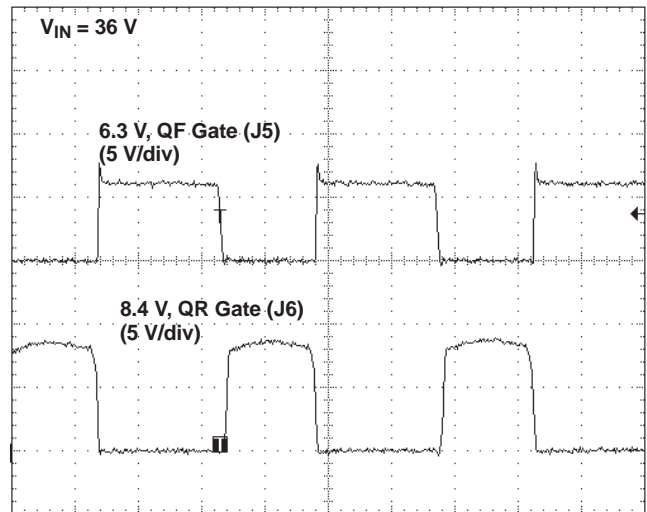

t – Time – 1 $\mu\text{s}/\text{div}$

Figure 12.

Transformer Primary

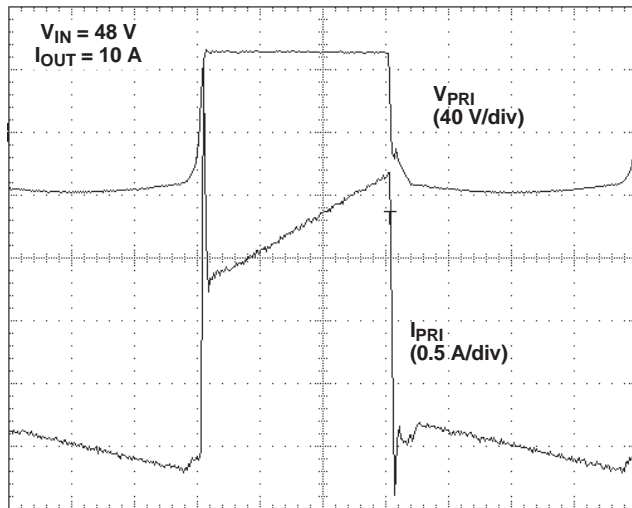

t – Time – 2.5 $\mu\text{s}/\text{div}$

Figure 11.

SR Gate Drive

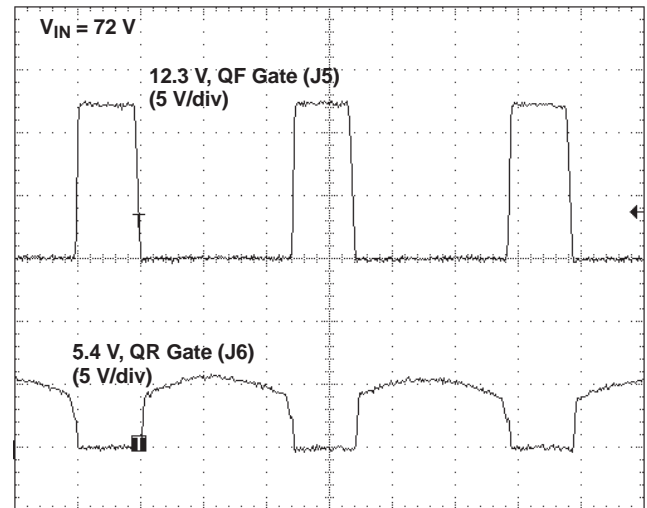

t – Time – 1 $\mu\text{s}/\text{div}$

Figure 13.

8 EVM Assembly Drawing and Layout

Figure 14 through Figure 20 show the top-side and bottom-side component placement for the EVM, as well as device pin numbers where necessary. A four layer PCB was designed using the top and bottom layers for signal traces and component placement along with an internal ground plane. The PCB dimensions are 3.6" x 2.7" with a design goal of fitting all components within the industry standard half-brick format, as outlined by the box dimensions 2.28" x 2.20" shown in Figure 15. All components are standard OTS surface mount components placed on the both sides of the PCB. The copper-etch for each layer is also shown.

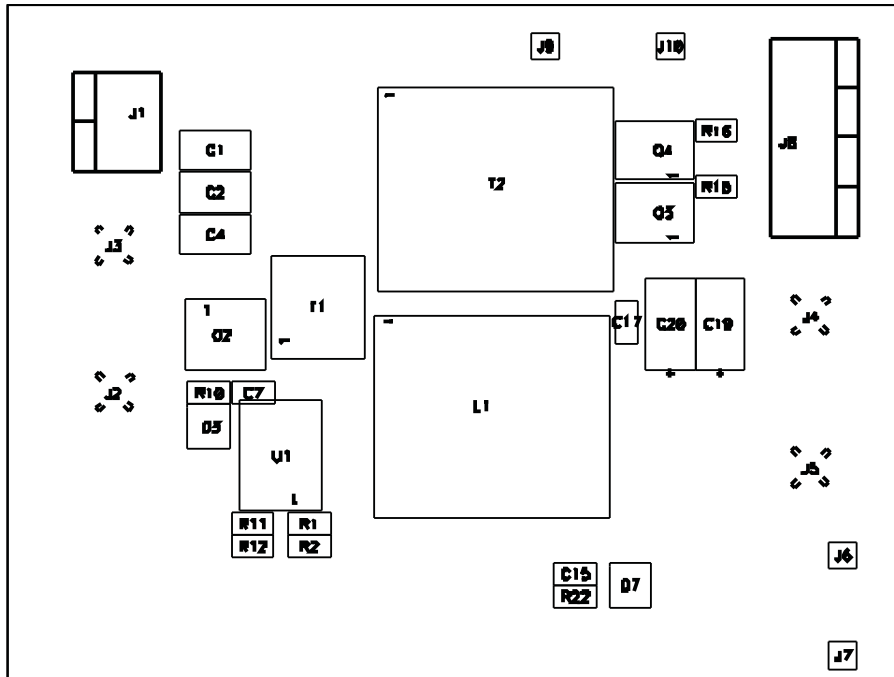

Figure 14. Top Side Component Assembly

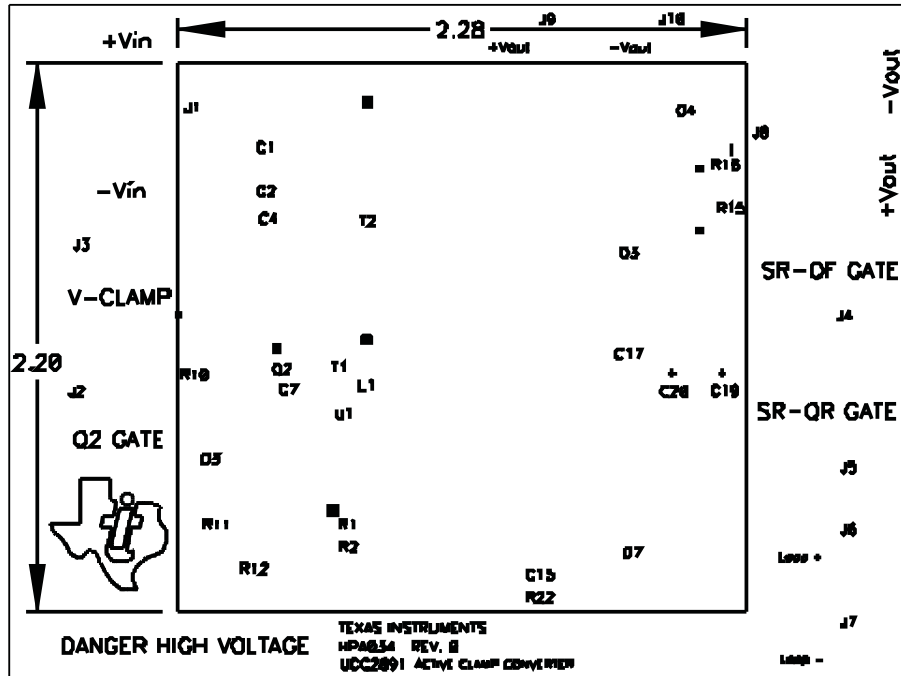

Figure 15. Top Side Silk Screen

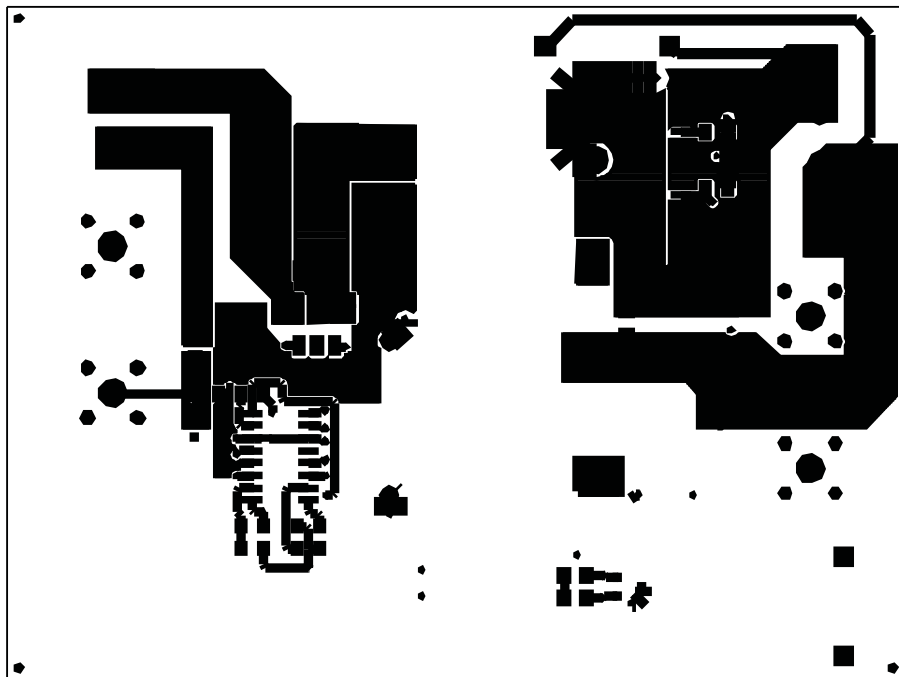

Figure 16. Top Signal Trace Layer

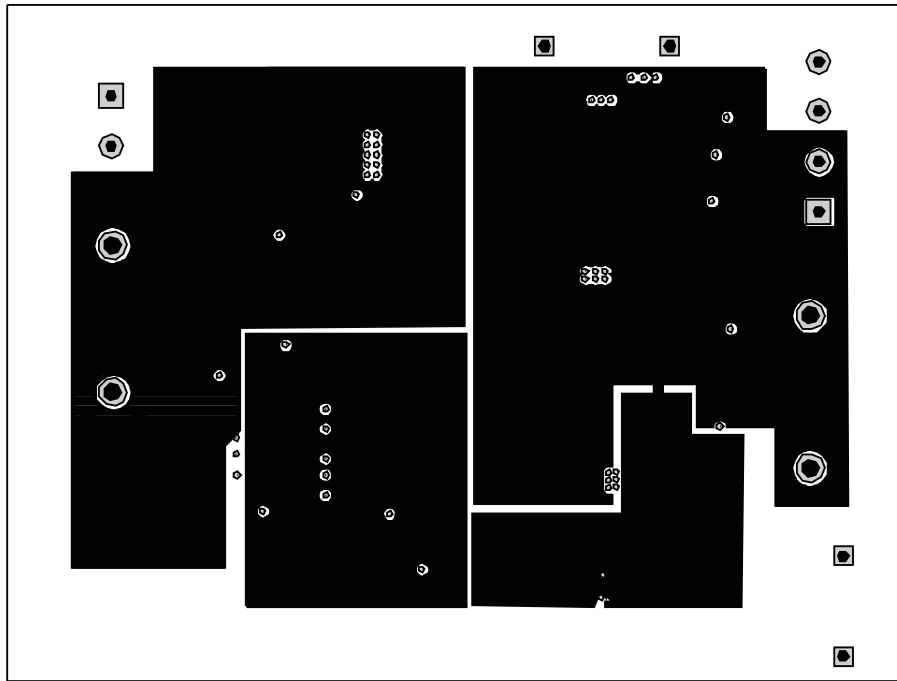

Figure 17. Internal Split Ground Plane

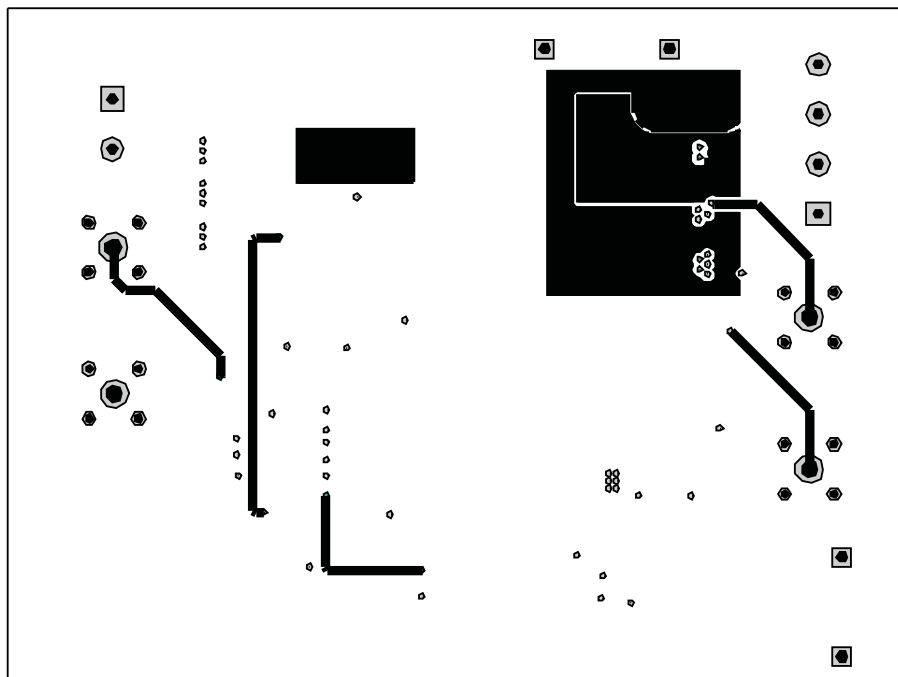

Figure 18. Internal Signal Trace Layer

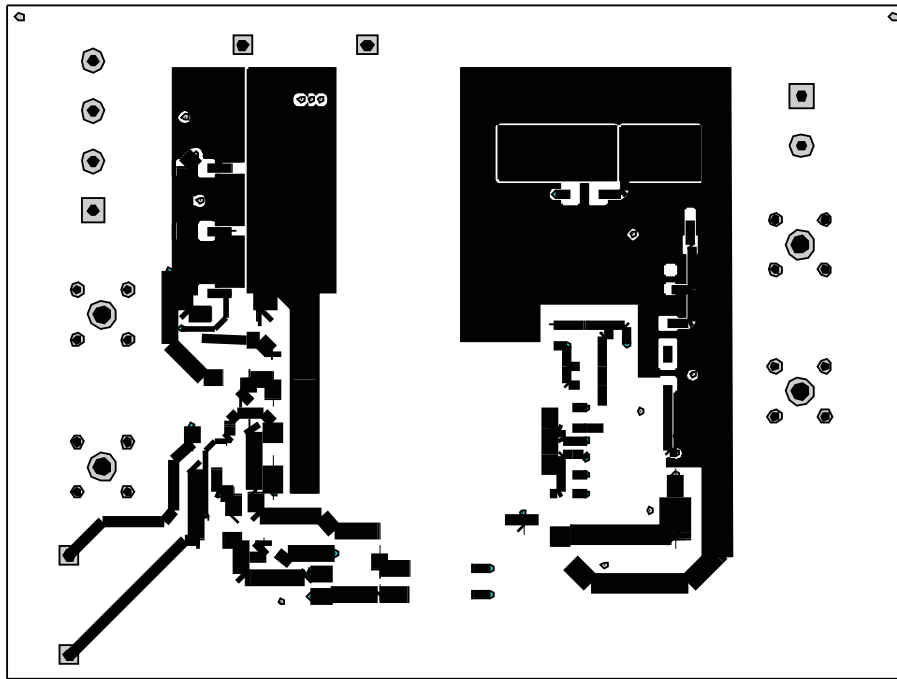

Figure 19. Bottom Signal Trace Layer

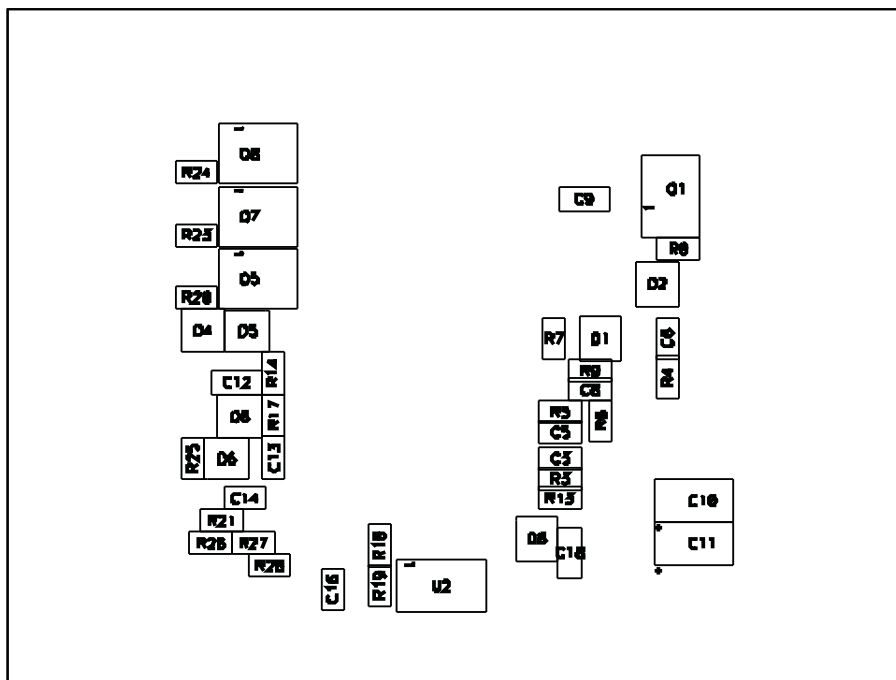

Figure 20. Bottom Side Component Assembly

9 List of Materials

The following table lists the UCC2891EVM components corresponding to the schematic shown in [Figure 1](#).

Table 2. List of Materials

REF	QTY	DESCRIPTION	MFR	PART NUMBER
C1, C2, C4	3	Capacitor, ceramic, 2.2 μ F, 100 V, X7R, 20%, 1812	TDK	C4532X7R2A225M
C3, C14, C17	3	Capacitor, ceramic, 0.1 μ F, 50 V, X7R, 20%, 805	Vishay	VJ0805Y104MXAA
C5	1	Capacitor, ceramic, 100 pF, 50 V, NPO, 10%, 805	Vishay	VJ0805A101KXAA
C6, C7	2	Capacitor, ceramic, 0.22 μ F, 50 V, X7R, 20%, 805	TDK	C2012X7R1H224M
C8	1	Capacitor, ceramic, 10 nF, 50 V, X7R, 20%, 805	Vishay	VJ0805Y103MXAA
C9	1	Capacitor, ceramic, 33 nF, 250 V, X7R, 10%, 1206	MuRata	GRM31CR72E333KW03L
C10, C11	2	Capacitor, tantalum chip, 47 μ F, 16 V, C	Vishay	595D476X9016C2T
C12, C18	2	Capacitor, ceramic, 10 μ F, 16 V, X5R, 20%, 1206	TDK	C3216X5R1C106M
C13	1	Capacitor, ceramic, 1.5 μ F, 10 V, X5R, 20%, 805	TDK	C2012X5R1A155M
C15	1	Capacitor, ceramic, 82 nF, 50 V, X7R, 10%, 805	Vishay	VJ0805Y823KXAA
C16	1	Capacitor, ceramic, 220 pF, 50 V, NPO, 10%, 805	Vishay	VJ0805A221KXAA
C19, C20	2	Capacitor, POSCAP, 330 μ F, 6.3 V, 20%, 7343 (D)	Sanyo	6TPD330M
D1, D2, D3, D4, D5	5	Diode, schottky, 200 mA, 30 V, SOT23	Vishay	BAT54
D8	1	Diode, switching, 200 mA, 200 V, SOT23	Philips/NXP	BAS21
D6	1	Diode, zener, 5.1 V, 350 mW, SOT23	Vishay	BZX84C5V1
D7	1	Adjustable precision shunt regulator, 0.5%, SOT23	TI	TLV431BCDBZ
J1	1	Terminal block, 2 pin, 15 A, 5.1 mm, 0.40 \times 0.35	OST	ED500/2DS
J2, J3, J4, J5	4	Adaptor, 3.5 mm probe clip (or 131-5031-00), 3.5 mm	Tektronix	131 4244 00
J6, J7, J9, J10	4	Printed circuit pin, 0.043 hole, 0.3 length, 0.043	Mill Max	3103-1-00-15-00-00-0X-0
J8	1	Terminal block, 4 pin, 15 A, 5.1mm, 0.80 \times 0.35	OST	ED500/4DS
L1	1	Inductor, 2 μ H, 1 pri, 1 sec, 0.920 \times 0.780	Pulse	PA0373
Q1	1	MOSFET, P-channel, 150 V, 2.2 A, 240 m Ω , SO-8	IR	IRF6216
Q2	1	MOSFET, N-channel, 150 V, 6.7 A, 50 m Ω , PowerPak SO-8	Vishay	Si7846DP
Q3, Q4, Q5, Q7, Q8	5	MOSFET, N-channel, 30 V, 55 A, 2.5 m Ω , LFPAK	Renesas	HAT2165H
Q6	1	Bipolar, NPN, 40 V, 600 mA, 225 mW, SOT23	Vishay	MMBT2222A

Table 2. List of Materials (continued)

REF	QTY	DESCRIPTION	MFR	PART NUMBER
R1	1	Resistor, chip, 8.45 k Ω , 1/10 W, 1%, 805	Vishay	CRCW0805-8451-F
R2	1	Resistor, chip, 57.6 k Ω , 1/10 W, 1%, 805	Vishay	CRCW0805-5762-F
R3	1	Resistor, chip, 76.8 k Ω , 1/10 W, 1%, 805	Vishay	CRCW0805-7682-F
R4, R10, R15, R16, R20, R23, R24	7	Resistor, chip, 2.21 Ω , 1/10 W, 1%, 805	Vishay	CRCW0805-2R21-F
R5	1	Resistor, chip, 158 k Ω , 1/10 W, 1%, 805	Vishay	CRCW0805-1583-F
R6	1	Resistor, chip, 1.82 k Ω , 1/10 W, 1%, 805	Vishay	CRCW0805-1821-F
R7, R8, R12	3	Resistor, chip, 1 k Ω , 1/10 W, 1%, 805	Vishay	CRCW0805-1001-F
R9	1	Resistor, chip, 11.8 Ω , 1/10 W, 1%, 805	Vishay	CRCW0805-11R8-F
R11	1	Resistor, chip, 26.7 k Ω , 1/10 W, 1%, 805	Vishay	CRCW0805-2672-F
R13	1	Resistor, chip, 2 k Ω , 1/10 W, 1%, 805	Vishay	CRCW0805-2001-F
R14	1	Resistor, chip, 10 Ω , 1/10 W, 1%, 805	Vishay	CRCW0805-10R0-F
R17, R18	2	Resistor, chip, 499 Ω , 1/10 W, 1%, 805	Vishay	CRCW0805-4990-F
R19	1	Resistor, chip, 665 Ω , 1/10 W, 1%, 805	Vishay	CRCW0805-6650-F
R21, R22	2	Resistor, chip, 10 k Ω , 1/10 W, 1%, 805	Vishay	CRCW0805-1002-F
R25	1	Resistor, chip, 51.1 Ω , 1/10 W, 1%, 805	Vishay	CRCW0805-51R1-F
R26	1	Resistor, chip, 28.7 k Ω , 1/10 W, 1%, 805	Vishay	CRCW0805-2872-F
R27	1	Resistor, chip, 12.1 k Ω , 1/10 W, 1%, 805	Vishay	CRCW0805-1212-F
R28	1	Resistor, chip, 4.99 k Ω , 1/10 W, 1%, 805	Vishay	CRCW0805-4991-F
T1	1	Transformer, current sense, 10-A, 1:100, SMD	Pulse	P8208
T2	1	Transformer, high-frequency planar, planar	Pulse	PA0810
U1	1	IC, current mode active clamp PWM controller, SO-16	TI	UCC2891D
U2	1	IC, phototransistor, CTR 100%-300%, SOP-4	Vishay	SFH690BT

10 References

1. UCC2891 Current Mode Active Clamp PWM Controller, Datasheet, (SLUS542)
2. Designing for High Efficiency with the UCC2891 Active Clamp PWM Controller, by Steve Mappus, Application Note (SLUA299)

EVM IMPORTANT NOTICE

Texas Instruments (TI) provides the enclosed product(s) under the following conditions:

This evaluation kit being sold by TI is intended for use for **ENGINEERING DEVELOPMENT OR EVALUATION PURPOSES ONLY** and is not considered by TI to be fit for commercial use. As such, the goods being provided may not be complete in terms of required design-, marketing-, and/or manufacturing-related protective considerations, including product safety measures typically found in the end product incorporating the goods. As a prototype, this product does not fall within the scope of the European Union directive on electromagnetic compatibility and therefore may not meet the technical requirements of the directive.

Should this evaluation kit not meet the specifications indicated in the EVM User's Guide, the kit may be returned within 30 days from the date of delivery for a full refund. THE FOREGOING WARRANTY IS THE EXCLUSIVE WARRANTY MADE BY SELLER TO BUYER AND IS IN LIEU OF ALL OTHER WARRANTIES, EXPRESSED, IMPLIED, OR STATUTORY, INCLUDING ANY WARRANTY OF MERCHANTABILITY OR FITNESS FOR ANY PARTICULAR PURPOSE.

The user assumes all responsibility and liability for proper and safe handling of the goods. Further, the user indemnifies TI from all claims arising from the handling or use of the goods. Please be aware that the products received may not be regulatory compliant or agency certified (FCC, UL, CE, etc.). Due to the open construction of the product, it is the user's responsibility to take any and all appropriate precautions with regard to electrostatic discharge.

EXCEPT TO THE EXTENT OF THE INDEMNITY SET FORTH ABOVE, NEITHER PARTY SHALL BE LIABLE TO THE OTHER FOR ANY INDIRECT, SPECIAL, INCIDENTAL, OR CONSEQUENTIAL DAMAGES.

TI currently deals with a variety of customers for products, and therefore our arrangement with the user **is not exclusive**.

TI assumes **no liability for applications assistance, customer product design, software performance, or infringement of patents or services described herein**.

Please read the EVM User's Guide and, specifically, the EVM Warnings and Restrictions notice in the EVM User's Guide prior to handling the product. This notice contains important safety information about temperatures and voltages. For further safety concerns, please contact the TI application engineer.

Persons handling the product must have electronics training and observe good laboratory practice standards.

No license is granted under any patent right or other intellectual property right of TI covering or relating to any machine, process, or combination in which such TI products or services might be or are used.

Mailing Address:

Texas Instruments
Post Office Box 655303
Dallas, Texas 75265

DYNAMIC WARNINGS AND RESTRICTIONS

It is important to operate this EVM within the input voltage range of 0 Vdc to 72 Vdc.

Exceeding the specified input range may cause unexpected operation and/or irreversible damage to the EVM. If there are questions concerning the input range, please contact a TI field representative prior to connecting the input power.

Applying loads outside of the specified output range may result in unintended operation and/or possible permanent damage to the EVM. Please consult the EVM User's Guide prior to connecting any load to the EVM output. If there is uncertainty as to the load specification, please contact a TI field representative.

During normal operation, some circuit components may have case temperatures greater than 50°C. The EVM is designed to operate properly with certain components above 50°C as long as the input and output ranges are maintained. These components include but are not limited to linear regulators, switching transistors, pass transistors, and current sense resistors. These types of devices can be identified using the EVM schematic located in the EVM User's Guide. When placing measurement probes near these devices during operation, please be aware that these devices may be very warm to the touch.

Mailing Address:

Texas Instruments
Post Office Box 655303
Dallas, Texas 75265

IMPORTANT NOTICE

Texas Instruments Incorporated and its subsidiaries (TI) reserve the right to make corrections, modifications, enhancements, improvements, and other changes to its products and services at any time and to discontinue any product or service without notice. Customers should obtain the latest relevant information before placing orders and should verify that such information is current and complete. All products are sold subject to TI's terms and conditions of sale supplied at the time of order acknowledgment.

TI warrants performance of its hardware products to the specifications applicable at the time of sale in accordance with TI's standard warranty. Testing and other quality control techniques are used to the extent TI deems necessary to support this warranty. Except where mandated by government requirements, testing of all parameters of each product is not necessarily performed.

TI assumes no liability for applications assistance or customer product design. Customers are responsible for their products and applications using TI components. To minimize the risks associated with customer products and applications, customers should provide adequate design and operating safeguards.

TI does not warrant or represent that any license, either express or implied, is granted under any TI patent right, copyright, mask work right, or other TI intellectual property right relating to any combination, machine, or process in which TI products or services are used. Information published by TI regarding third-party products or services does not constitute a license from TI to use such products or services or a warranty or endorsement thereof. Use of such information may require a license from a third party under the patents or other intellectual property of the third party, or a license from TI under the patents or other intellectual property of TI.

Reproduction of TI information in TI data books or data sheets is permissible only if reproduction is without alteration and is accompanied by all associated warranties, conditions, limitations, and notices. Reproduction of this information with alteration is an unfair and deceptive business practice. TI is not responsible or liable for such altered documentation. Information of third parties may be subject to additional restrictions.

Resale of TI products or services with statements different from or beyond the parameters stated by TI for that product or service voids all express and any implied warranties for the associated TI product or service and is an unfair and deceptive business practice. TI is not responsible or liable for any such statements.

TI products are not authorized for use in safety-critical applications (such as life support) where a failure of the TI product would reasonably be expected to cause severe personal injury or death, unless officers of the parties have executed an agreement specifically governing such use. Buyers represent that they have all necessary expertise in the safety and regulatory ramifications of their applications, and acknowledge and agree that they are solely responsible for all legal, regulatory and safety-related requirements concerning their products and any use of TI products in such safety-critical applications, notwithstanding any applications-related information or support that may be provided by TI. Further, Buyers must fully indemnify TI and its representatives against any damages arising out of the use of TI products in such safety-critical applications.

TI products are neither designed nor intended for use in military/aerospace applications or environments unless the TI products are specifically designated by TI as military-grade or "enhanced plastic." Only products designated by TI as military-grade meet military specifications. Buyers acknowledge and agree that any such use of TI products which TI has not designated as military-grade is solely at the Buyer's risk, and that they are solely responsible for compliance with all legal and regulatory requirements in connection with such use.

TI products are neither designed nor intended for use in automotive applications or environments unless the specific TI products are designated by TI as compliant with ISO/TS 16949 requirements. Buyers acknowledge and agree that, if they use any non-designated products in automotive applications, TI will not be responsible for any failure to meet such requirements.

Following are URLs where you can obtain information on other Texas Instruments products and application solutions:

Products		Applications	
Amplifiers	amplifier.ti.com	Audio	www.ti.com/audio
Data Converters	dataconverter.ti.com	Automotive	www.ti.com/automotive
DSP	dsp.ti.com	Broadband	www.ti.com/broadband
Interface	interface.ti.com	Digital Control	www.ti.com/digitalcontrol
Logic	logic.ti.com	Military	www.ti.com/military
Power Mgmt	power.ti.com	Optical Networking	www.ti.com/opticalnetwork
Microcontrollers	microcontroller.ti.com	Security	www.ti.com/security
RFID	www.ti-rfid.com	Telephony	www.ti.com/telephony
Low Power Wireless	www.ti.com/lpw	Video & Imaging	www.ti.com/video
		Wireless	www.ti.com/wireless

Mailing Address: Texas Instruments, Post Office Box 655303, Dallas, Texas 75265
Copyright © 2007, Texas Instruments Incorporated